



FEDERATION INTERNATIONALE
DE L'AUTOMOBILE

Homologation N°

2020-01-XCAR-GSXR

XC Engine
SUZUKI GSXR 2011 - 2017

FICHE D'HOMOLOGATION
HOMOLOGATION FORM

Homologation valable à partir du
Homologation valid as from

20/05/2020

1. GENERALITES / GENERAL

101. CONSTRUCTEUR / MANUFACTURER

SUZUKI

3. MOTEUR / ENGINE

307. CYLINDRÉE MAXIMALE / MAXIMUM CYLINDER CAPACITY

a) Unitaire Unitary	150.0	cm3
b) Totale Total	600.0	cm3

309. MASSE MINIMUM / MINIMUM WEIGHT

a) Pesé comme décrit dans le règlement Weighted as described in the regulations	54.0	kg
--	------	----

314. ALÉSAGE / BORE

67.0	+0 - 0.1 mm
------	----------------

316. COURSE / STROKE

42.5	+0 - 0.1 mm
------	----------------

C1-1) Moteur déposé – vu de profil
Dismounted engine – seen from the side



C1-2) Moteur déposé – vu de profil
Dismounted engine – seen from the side



C1-3) Couvre culasse - déposé
Cylinderhead cover - dismounted



C1-4) Couvre culasse - déposé
Cylinderhead cover - dismounted



311. BLOC-CYLINDRES / CYLINDER BLOCK

- a) Matériau
Material **Aluminium**

C3-1) Bloc-cylindre nu vu de dessus
Bare cylinder block seen from above

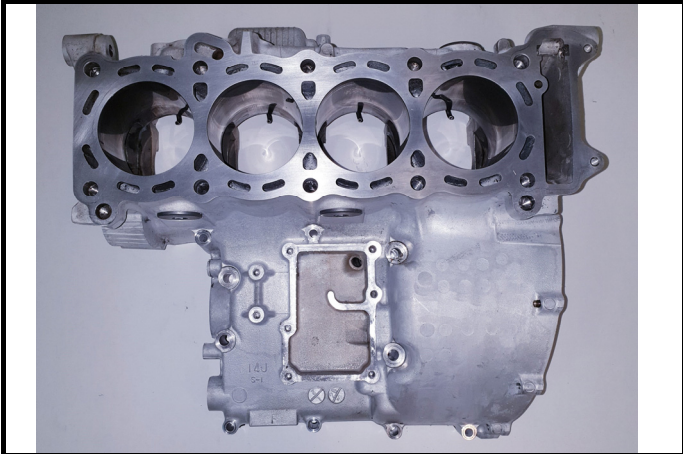

C3-2) Bloc-cylindre nu vu de dessous
Bare cylinder block seen from underneath

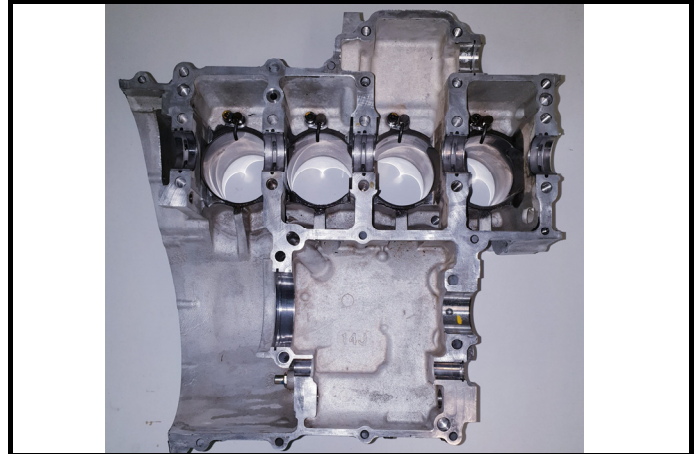

C3-3) Bloc-cylindre nu vu côté droit
Bare cylinder block seen from right hand side

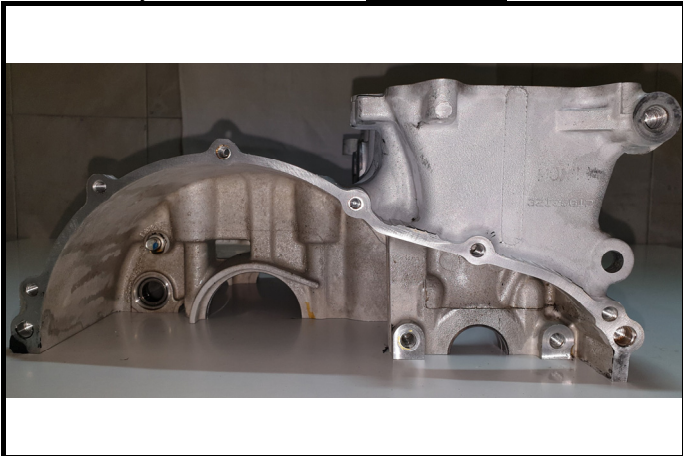

C3-4) Bloc-cylindre nu vu de côté gauche
Bare cylinder block seen from left hand side



C3-5) Bloc-cylindre nu vu côté Echappement
Bare cylinder block seen from exhaust side

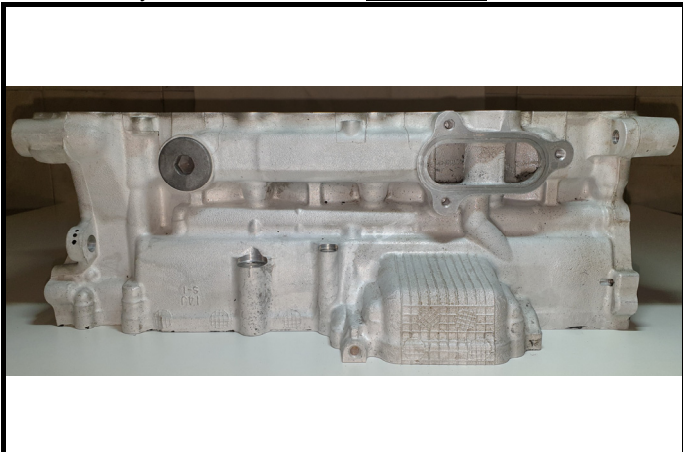

C3-6) Bloc-cylindre nu vu de côté Admission
Bare cylinder block seen from intake side

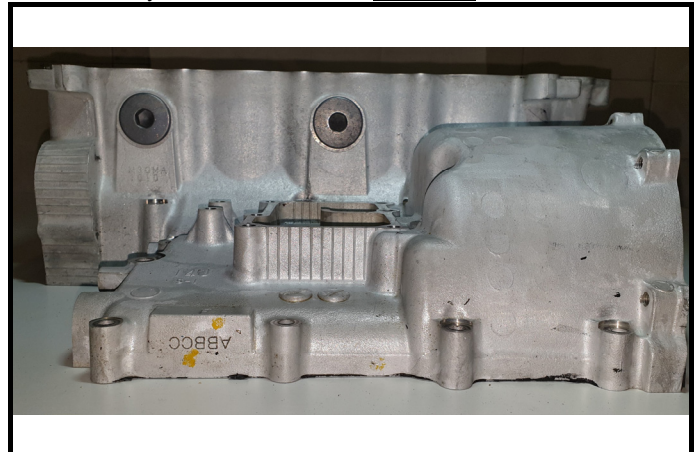

C3-7) Chapeaux de paliers de vilebrequin
Crankshaft bearing caps

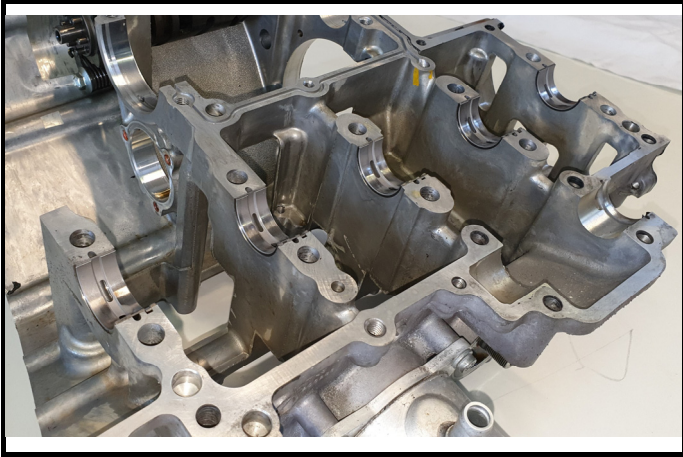

C3-8) Déflecteur d'huile sur le bloc moteur
Oil deflector on engine block

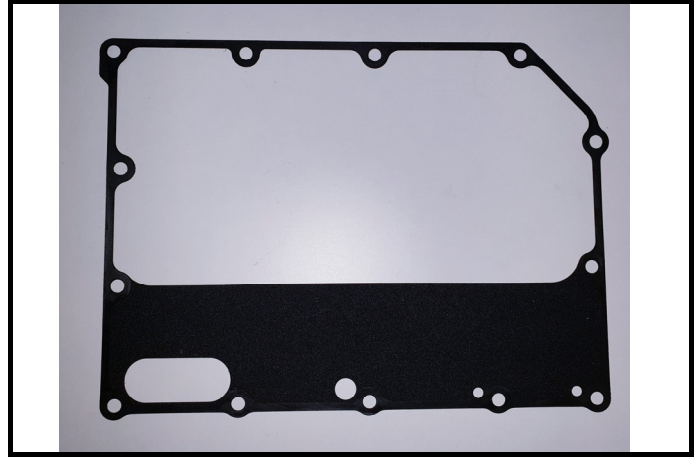

307. SYSTÈME D'ARBRES D'ÉQUILIBRAGE / BALANCING SHAFT SYSTEM

- a) Matériau des arbres d'équilibrage
Balancing shafts material **NA**
- b) Masse des arbres d'équilibrage
Balancing shafts weight **NA**

C3-9) Arbres déquilibrage - démontés
Balancing shafts - dismantled

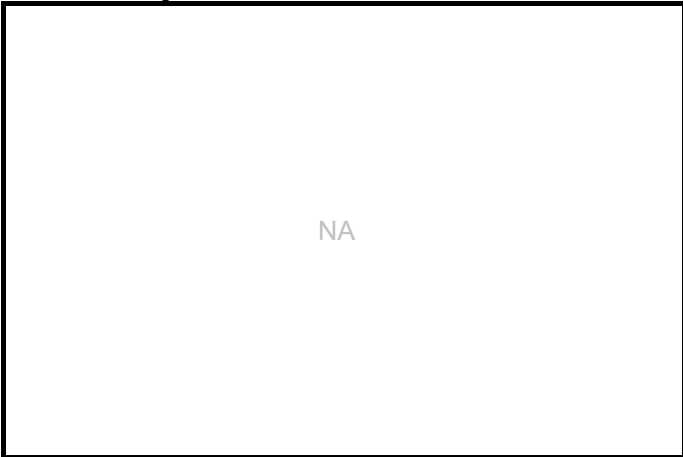

C3-10) Arbres déquilibrage - démontés
Balancing shafts - dismantled

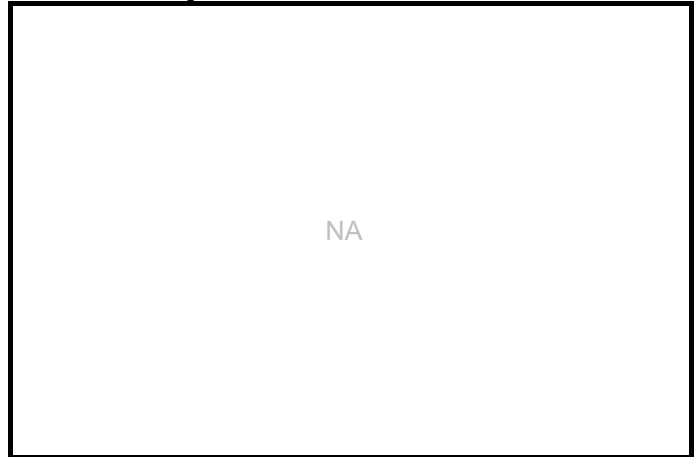

312. HAUTEUR MIN. DU BLOC-CYLINDRES / MIN. HEIGHT OF THE CYLINDER BLOCK

III-C1) Mesure de la hauteur / Height measurement

a) Entre plans de joint carter et culasse
Between sump and head gasket planes **134.95** mm

b) Entre axe vilebrequin et plan de joint culasse
Between crankshaft centreline and head gasket plane **134.95** mm

313. CHEMISES / SLEEVES

- | | | |
|---|--|--|
| a) Bloc cylindres chemisé
Sleeved cylinder block | Oui / Yes
<input type="checkbox"/> | Non / No
<input checked="" type="checkbox"/> |
| b) Matériau
Material | Nikasil | |
| c) Type
Type | Humides
Wet
<input type="checkbox"/> | Sèches
Dry
<input checked="" type="checkbox"/> |

C3-8) Chemise démontée (Origine)
Sleeve dismantled (Original)

NA

C3-9) Chemise démontée (Réparation)
Sleeve dismantled (Repair)

NA

317. PISTON / PISTON

- | | | | |
|---|------------------|--|---|
| a) Matériau
Material | Aluminium | | |
| b) Nombre de segments
Number of rings | 3 | b1) Epaisseur des segments
Thickness of rings | 1 - 0.8 - 1.5 + 0.1
-0.05 mm |
| c) Poids minimum
Minimum weight | 153 | g | <u>Avec axe, bagues, clips et segments</u>
<u>With pin, bearing, clips and rings</u> |
| d1) Hauteur de compression minimale
Minimum compression height | 21.2 | mm | |

C4-1) Piston de ¾ dessus
Piston from ¾ top



C4-2) Piston de ¾ dessous
Piston from ¾ bottom

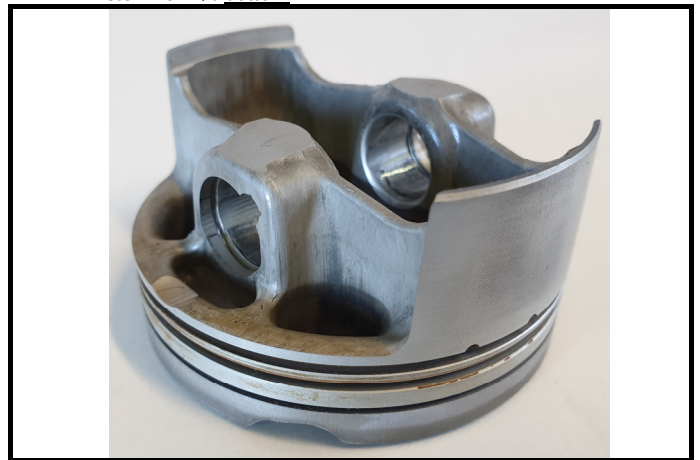

C4-3) Piston segments
Piston rings



III-D1) Axe de piston
Piston pin

± 0.1 mm tolerance

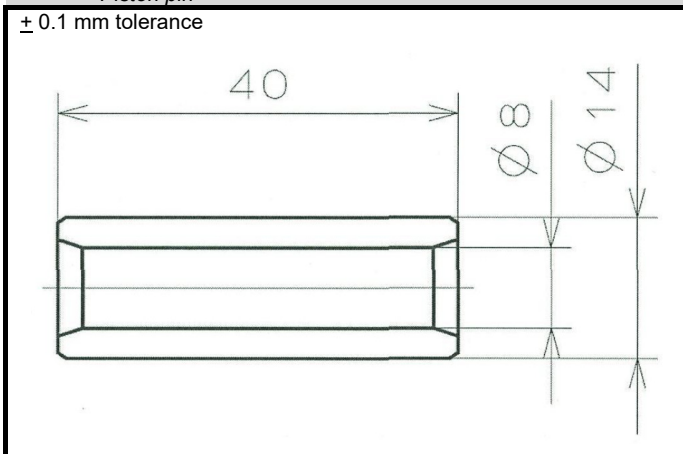

III-D2) Hauteur de compression minimale
Minimum compression height

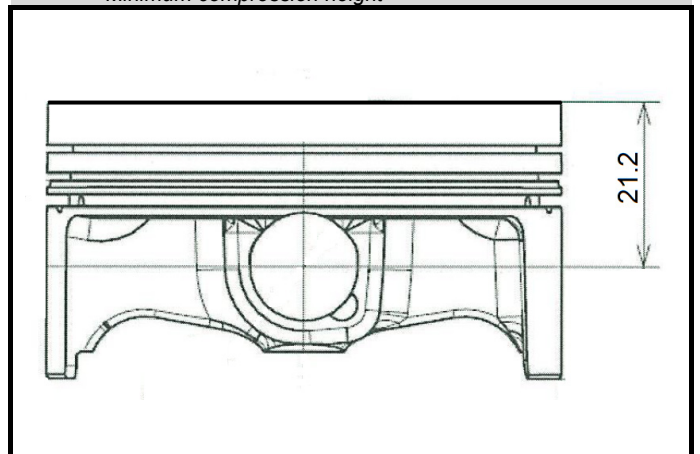

318. BIELLE / CONNECTING ROD

a) Matériau Material	Acier Steel	b) Type de la tête de bielle Big end type	Séparée Split
c) Diamètre intérieur de la tête de bielle (sans coussinets) Interior diameter of the big end (without shell bearings)		34.0	+0.1 - 0 mm
d) Longueur entre axes Length between axes	92.3		± 0.1 mm
		e) Poids minimum Minimum weight	285 g

C5-1) Bielle de ¾ côté tête
Connecting rod from ¾ on big end side



C5-2) Bielle de ¾ arrière côté pied
Connecting rod from ¾ rear on small end side



319. VILEBREQUIN / CRANKSHAFT

a) Type de construction Type of manufacture	Two pieces	b) Matériau Material	Acier
c) Procédé de fabrication Manufacturing process	Coulé Cast <input type="checkbox"/>	Forgé Forged <input checked="" type="checkbox"/>	Usiné dans la masse Machined from raw <input type="checkbox"/>
f) Diamètre des tourillons Diameter of main journals	30		+0 - 0.1 mm
g) Matériau des chapeaux de paliers Bearing caps material	Aluminium		
h) Poids minimum du vilebrequin nu Minimum weight of bare crankshaft	6500		g
i) Diamètre des manetons Diameter of crank pins	31		+0 - 0.1 mm

C6-1) Vilebrequin de ¾ avant
Crankshaft from ¾ front

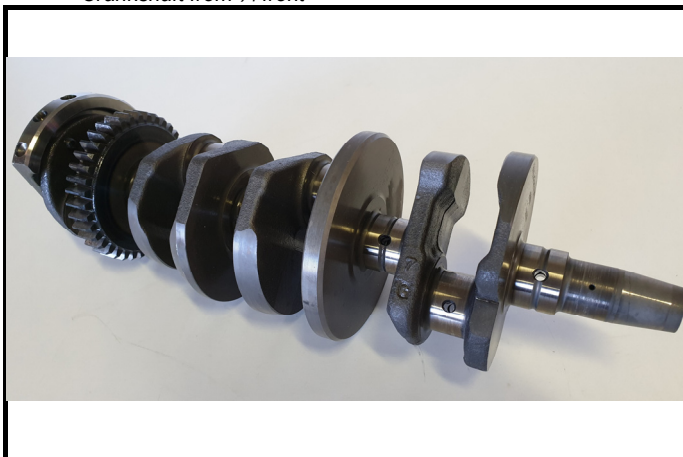

C6-2) Vilebrequin de ¾ arrière
Crankshaft from ¾ rear

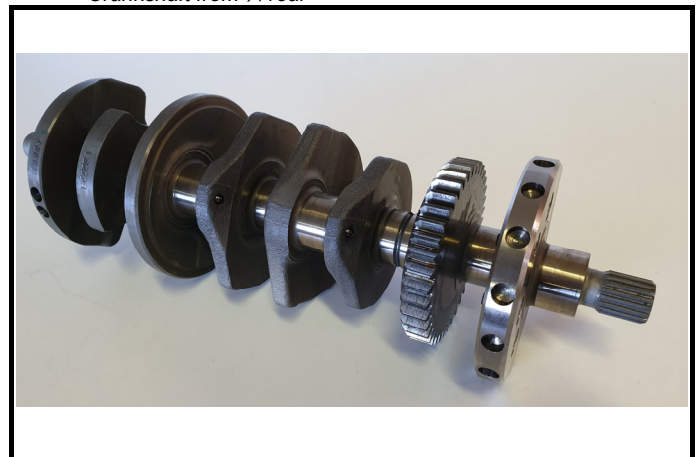

321. CULASSE / CYLINDERHEAD

- | | | | |
|--|---------------------------------------|-----|---|
| b) Matériau
<i>Material</i> | Aluminium | | |
| c) Hauteur minimum
<i>Minimum height</i> | 113.9 | mm | |
| d) Endroit de la mesure
<i>Where measured</i> | From cam cap face to fire face | | |
| g) Volume minimum d'une chambre de combustion
<i>Minimum volume of a combustion chamber</i> | 11.9 | cm3 | (Incl. Piston et Joint de culasse
<i>Incl. Piston and Cyl. Head Gasket</i>) |

C8-1) Culasse nue vue de dessus (côté arbres à cames)
Bare cylinderhead seen from top (camshaft side)

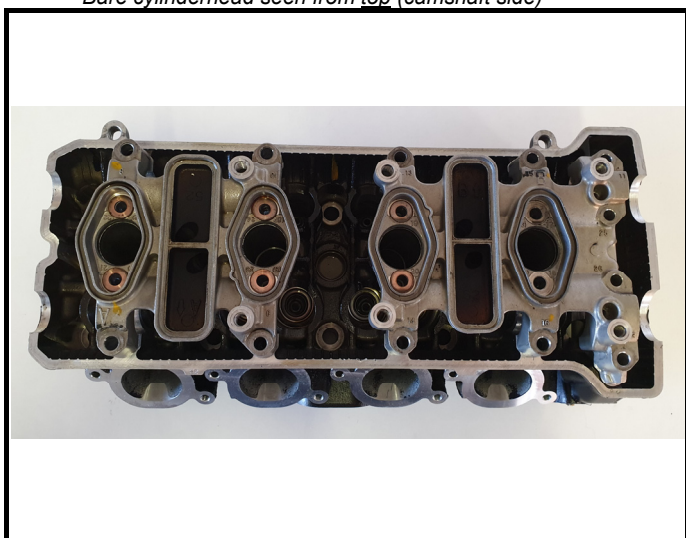

C8-2) Culasse nue vue de dessous (côté chambre)
Bare cylinderhead seen from underneath (chamber side)

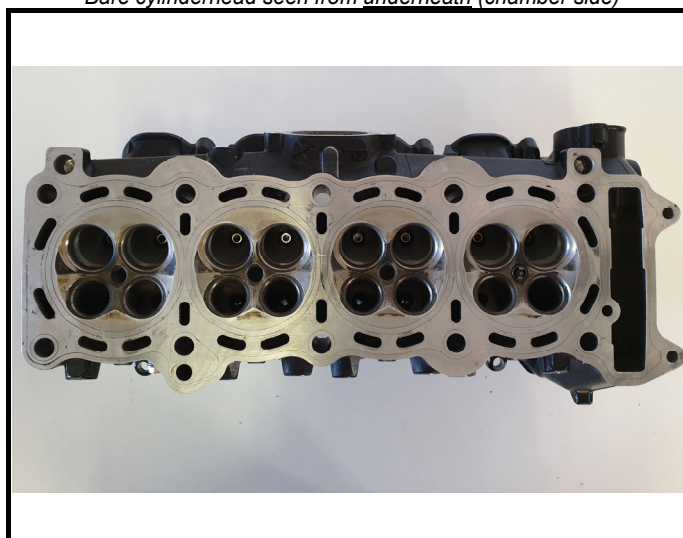

C8-3) Culasse nue vue côté admission
Bare cylinderhead seen from intake side



C8-4) Culasse nue vue côté échappement
Bare cylinderhead seen from exhaust side



C8-5) Culasse nue vue côté gauche
Bare cylinderhead seen from left hand side

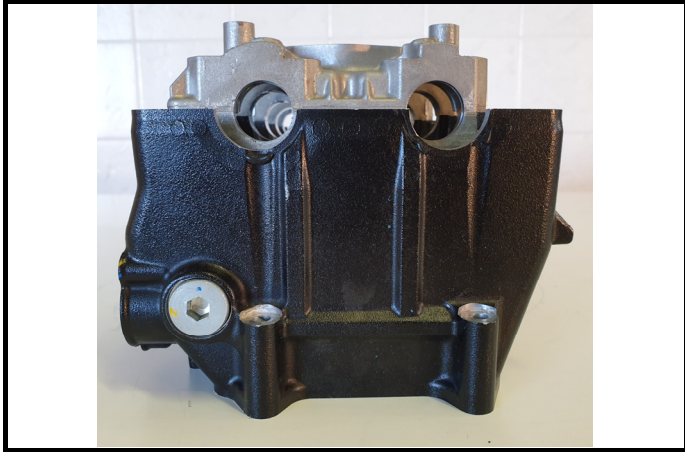

C8-6) Culasse nue vue côté droit
Bare cylinderhead seen from right hand side

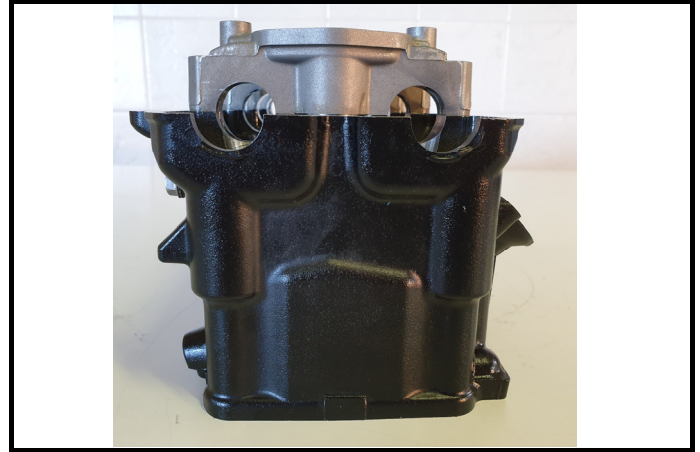

C8-7) Chambre de combustion
Combustion chamber

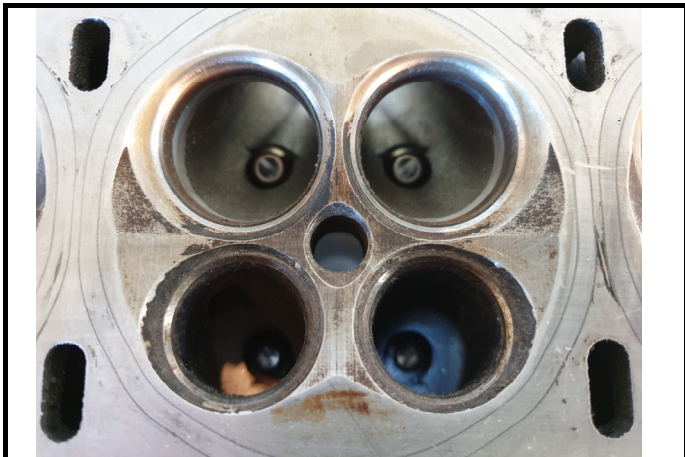

III-E1) Diamètre maximum au niveau du siège admission
Maximum intake seat diameter

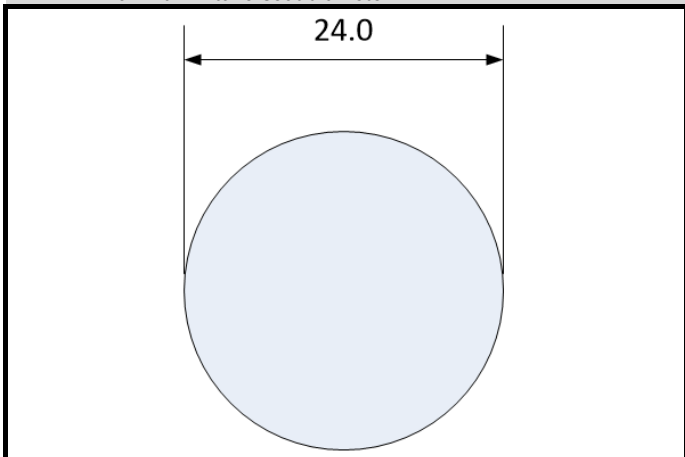

III-E2) Diamètre maximum au niveau du siège échappement
Maximum exhaust seat diameter

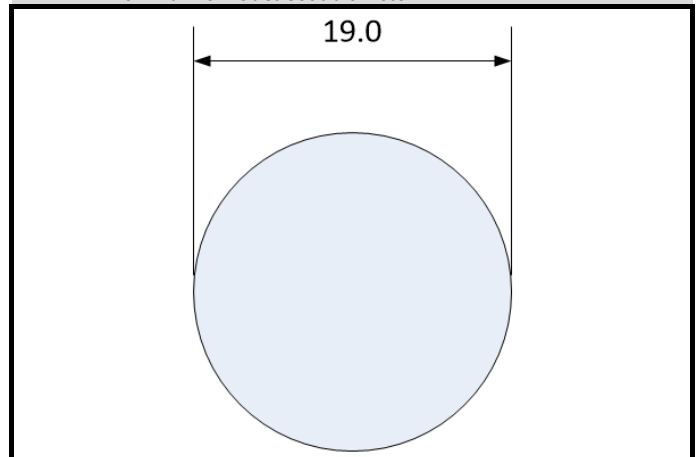

ADMISSION / INTAKE

Dessins des orifices de la culasse - tolérances sur les dimensions : $-2/+4$ %
Drawings of cylinder head ports - tolerances on dimensions : $-2/+4$ %

III-K1) Culasse, face collecteur / Cylinderhead, manifold side

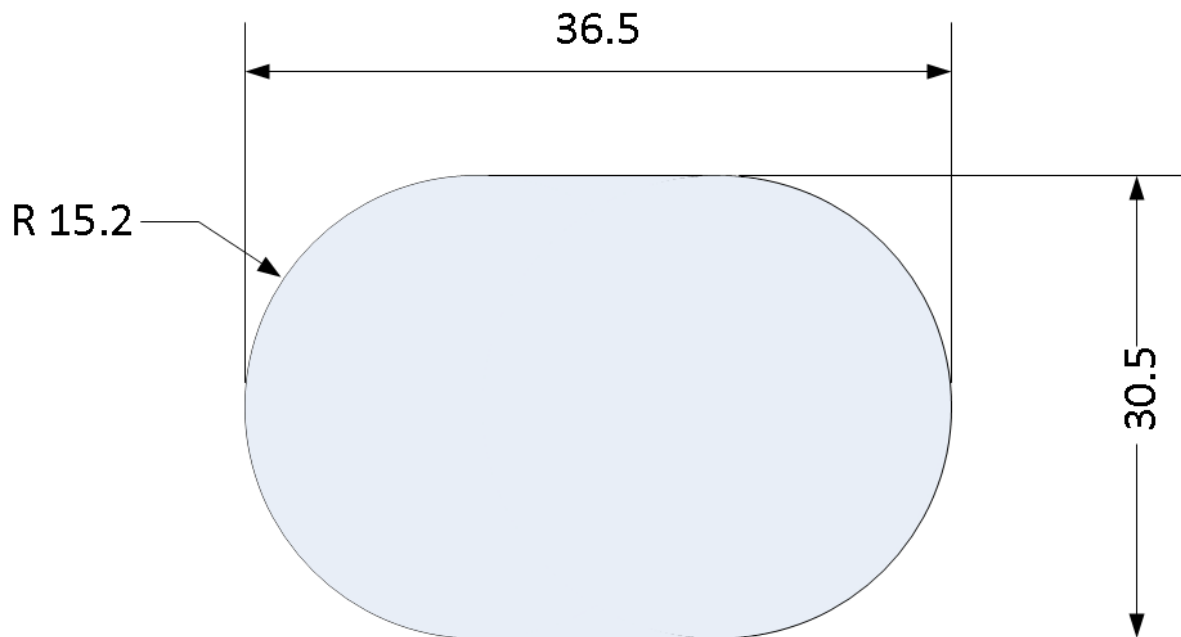
**ECHAPPEMENT / EXHAUST**

Dessins des orifices de la culasse - tolérances sur les dimensions : $-2/+4$ %
Drawings of cylinder head ports - tolerances on dimensions : $-2/+4$ %

III-L1) Culasse, face collecteur / Cylinderhead, manifold side

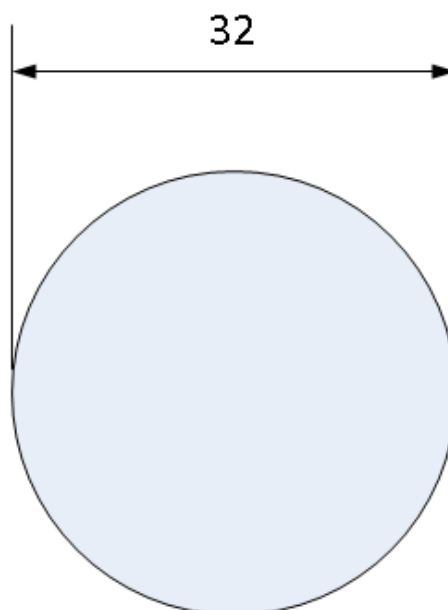

322. JOINT DE CULASSE / CYLINDERHEAD GASKET

- a) Epaisseur du joint de culasse serré
Thickness of tightened cylinderhead gasket **0.6** ± 0.1 mm
- b) Endroit de mesure
Location of measurement **Sur le côté, moteur monté / On side, engine assembled**

C8-14) Joint de culasse – déposé
Cylinderhead gasket – dismantled

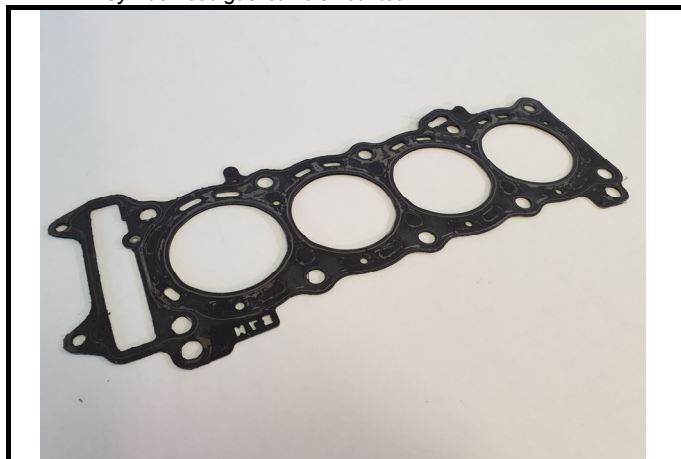

324. ALIMENTATION PAR INJECTION - ELECTRONIQUE / FUEL FEED BY INJECTION - ELECTRONICS

- a) Référence injecteurs bas
Low Injectors référence **15710-14J00-000**
- b) Référence injecteurs haut
High Injectors référence **15710-14J10-000**

C9-1) Injecteurs bas
Low Injectors low



C9-2) Nozzle Injecteurs bas
Low Injectors Nozzle



C9-1) Injecteurs haut
High *Injectors*



C9-2) Nozzle Injecteurs haut
High *Injectors Nozzle*



324. SYSTEME DE CONTROLE MOTEUR / ENGINE CONTROL SYSTEM

- a) Marque et type **MECTRONIK MKE7** Injection - Direct Injection - Indirect
Make and type
- Mécanique / *Mechanical* Electronique / *Electronic* Hydraulique / *Hydraulic*
- c) Dosage du carburant
Fuel measurement
- e) Nombre de sorties effectives de carburant **8**
- f) Injecteurs f1) Position Collecteur / *Manifold* Culasse / *Cylinder head*
Injectors *Position*
 Chambre *Chamber* Pré-chambre *Pre-chamber*
- g) Liste des capteurs du système de contrôle moteur
List of engine control system sensors

N°	Number	Function	Make & Reference
C1	x1	GEARBOX POSITION	37730-14J00-000
C2	x1	THROTTLE POSITION	13580-14J10-000
C3	x1	CAMSHAFT POSITION	33220-01H00-000
C4	x1	AIR CHARGE PRESSURE	15630-29G10-000
C5	x1	OIL ENGINE PRESSURE	37280-33D10-000
C6	x1	ENGINE SPEED	34990-35F00-000
C7	x1	TRANSMISSION SPEED	33110-14J00-000
C8	x1	WATER TEMP	13650-49X00-000
C9	x1	AIR TEMP	13650-14G10-000
C10	x1	LAMBDA	Bosch LS 17025 / 0 258 017 025
C12	x1	BAROMETRIC PRESSURE	15630-29G10-000

- h) Liste des actuateurs du système de contrôle moteur
List of engine control system actuators

N°	Number	Function	Make & Reference
A1	x1	SECONDARY ELECTRICAL THROTTLE	DE-ACTIVED : Not connected to the ECU
A2	x4	COILS	DENSO 129700 / 33410-37H00-000
A3	x4	FUEL INJECTORS LOW	EAT801 / 80112Z1 / 15710-14J00-000
A4	x4	FUEL INJECTORS HIGHT	EAT802 / 80212ZA / 15710-14J10-000

C9-1) Système de contrôle moteur
Engine control system

 C1	 C2	 C3	 C4
 C5	 C6	 C7	 C8
 C9	 C10	 C11	 C12
 C13	 C14	 C15	 C16
 A1	 A2	 A3	 A4
 A5	 A6	 A7	 A8

III-11) LOCALISATION DES CAPTEURS ET ACTIONNEURS / LOCATION OF SENSORS AND ACTUATORS

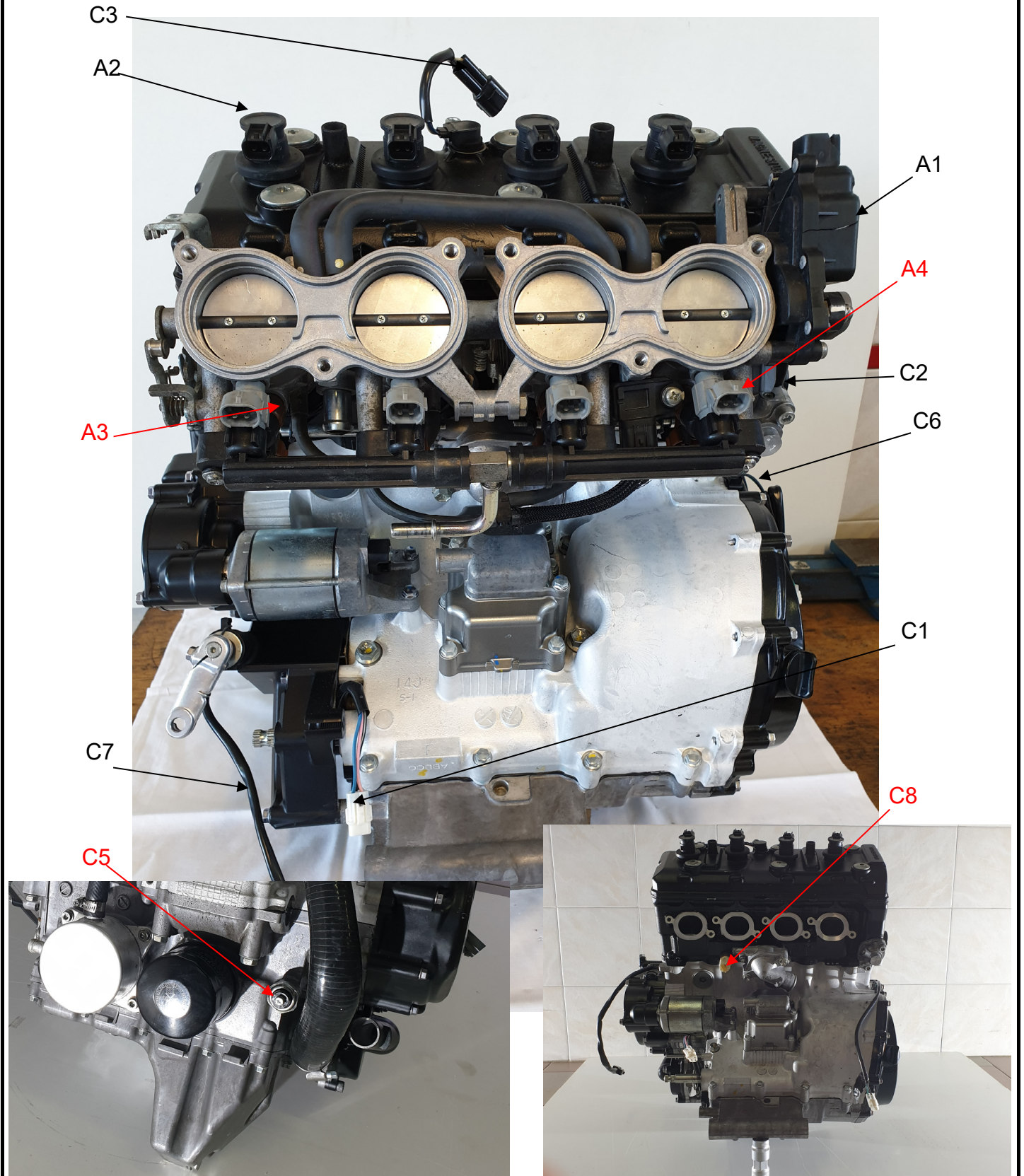

325. ARBRE A CAMES / CAMSHAFT

- c) Système d'entraînement
-
- Drive system

Chain

- e) Diamètre des tourillons
-
- Diameter of journals

24.0 ± 0.1 mm

- g) Dimensions de la came
-
- Cam dimensions

	Admission Intake	Echappement Exhaust
A =	28.1 ± 0.1 mm	28.1 ± 0.1 mm
B =	35.8 ± 0.1 mm	35.8 ± 0.1 mm

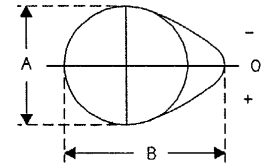

Les tolérances s'appliquent avec le même signe pour A et B
The tolerances must be used with the same sign for A and B

- h) Poids minimum
-
- Minimum weight

0.936	kg	0.954	kg
--------------	----	--------------	----

326. DISTRIBUTION / TIMING

- a) Jeu théorique
-
- Theoretical clearance

Admission
Intake **0,1** mmEchappement
Exhaust **0,2** mm

- b) Calage sommet de came

Admission
Intake **105** ± 2°Echappement
Exhaust **103.5** ± 2°

- c) Levée de came en mm (arbre déposé)
-
- Cam lift in mm (dismounted camshaft)

Mesuré avec bille de 3 mm de diamètre
Measured with a 3mm diameter ball

ADMISSION / INTAKE				ECHAPPEMENT / EXHAUST			
Angle de Rotation en degrés Rotation angle in degrees	Levée en mm Lift in mm (± 0.05 mm)	Angle de rotation en degrés Rotation angle in degrees	Levée en mm Lift in mm (± 0.05 mm)	Angle de rotation en degrés Rotation angle in degrees	Levée en mm Lift in mm (± 0.05 mm)	Angle de rotation en degrés Rotation angle in degrees	Levée en mm Lift in mm (± 0.05 mm)
0	7.81			0	7.79		
- 5	7.64	+ 5	7.55	- 5	7.57	+ 5	7.49
- 10	7.12	+ 10	6.95	- 10	6.99	+ 10	6.68
- 15	6.25	+ 15	5.98	- 15	6.07	+ 15	5.73
- 20	5.33	+ 20	4.90	- 20	4.94	+ 20	4.67
- 25	4.25	+ 25	3.88	- 25	3.94	+ 25	3.70
- 30	3.35	+ 30	2.99	- 30	3.05	+ 30	2.92
- 35	2.60	+ 35	2.28	- 35	2.32	+ 35	2.23
- 40	1.93	+ 40	1.69	- 40	1.73	+ 40	1.68
- 45	1.44	+ 45	1.25	- 45	1.25	+ 45	1.22
- 50	1.03	+ 50	0.90	- 50	0.88	+ 50	0.86
- 55	0.71	+ 55	0.64	- 55	0.61	+ 55	0.60
- 60	0.48	+ 60	0.47	- 60	0.42	+ 60	0.43
- 65	0.32	+ 65	0.36	- 65	0.30	+ 65	0.33
- 70	0.23	+ 70	0.29	- 70	0.23	+ 70	0.27
- 75	0.17	+ 75	0.24	- 75	0.16	+ 75	0.21
- 80	0.10	+ 80	0.18	- 80	0.09	+ 80	0.16
- 85	0.04	+ 85	0.12	- 85	0.03	+ 85	0.12
- 90	0.02	+ 90	0.06	- 90	0.01	+ 90	0.07

Un décalage de l'ensemble des mesures de +/- 2 degrés est accepté / + = Sens de rotation identique au moteur
A shift of +/- 2 degrees of the whole measurement is accepted / + = Same rotation direction as engine

- c) Levée maximum des soupapes
-
- Maximum valve lift

Admission Intake	Echappement Exhaust
7.7	7.6

avec jeu selon Art. 326a
with clearance according to Art. 326a

C10-1) Arbres à cames - déposé
Camshaft - *dismounted*



C10-2) Arbres à cames - déposé
Camshaft - *dismounted*



C10-5) Pignons arbres à cames- démontés
Camshafts gears - *dismounted*



III-J2) Culbuteur - dimensions caractéristiques
Rocker arm - *typical dimensions*

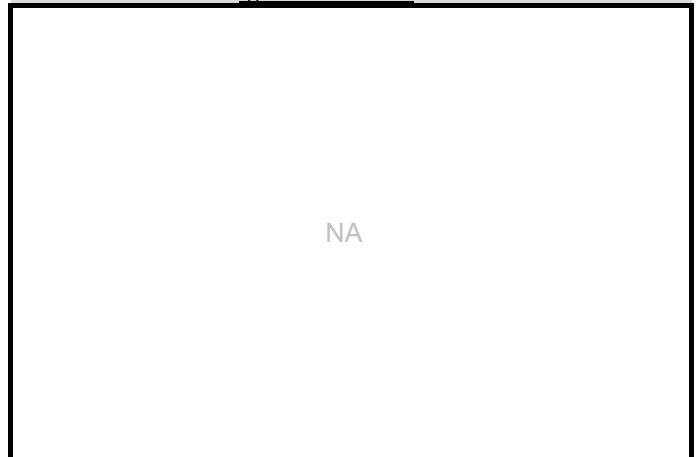

C10-6) Poussoir Admission - démonté
Tappet Intake - *dismounted*



III-J3) Poussoir Admission - dimensions caractéristiques
Tappet Intake - *typical dimensions*

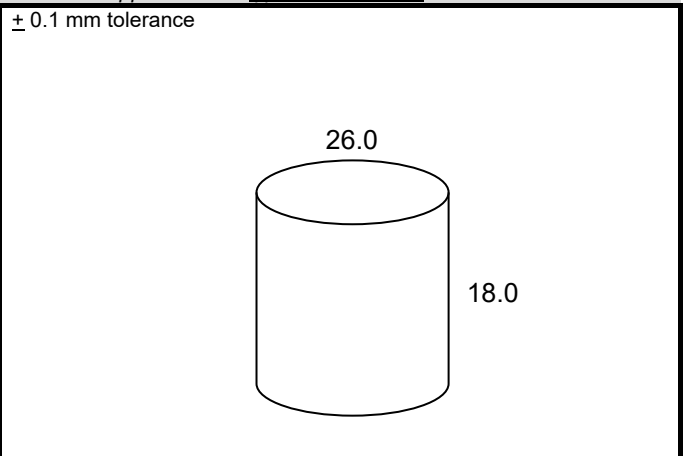

C10-7) Poussoir Echappement – démonté
Tappet Exhaust – dismounted



III-J4) Poussoir Echappement – dimensions caractéristiques
Tappet Exhaust – typical dimensions

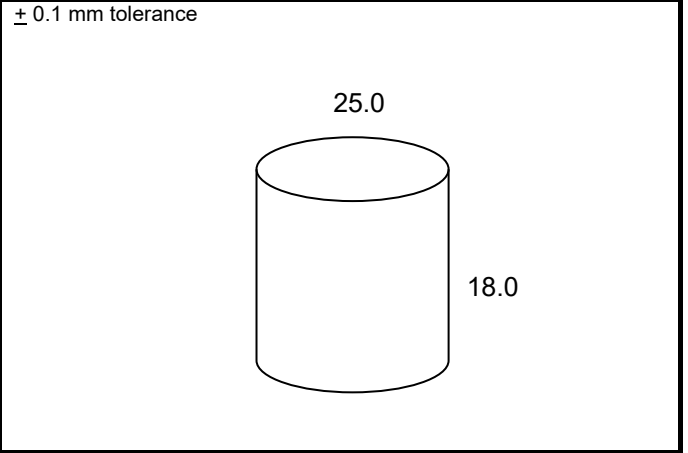

C10-8) Ressort soupape admission
Intake valve spring



C10-9) Ressort soupape échappement
Exhaust valve spring



- d) Long. ressort soupape admission libre
Intake valve spring free length **40.6** ± 1 mm
- e) Long. ressort soupape adm. sous 200 Nm
Intake valve spring length under 200 Nm **33.8** ± 1 mm
- g) Diamètre fil ressort soupape adm.
Intake valve spring wire diameter **2.8 x 3.5** ± 0.1 mm

- d) Long. ressort soupape échappement. libre
Exhaust valve spring free length **40.6** ± 1 mm
- f) Long. ressort soupape échap. sous 200 Nm
Exhaust valve spring length under 200 Nm **33.8** ± 1 mm
- h) Diamètre fil ressort soupape échap.
Exhaust valve spring wire diameter **2.8 x 3.5** ± 0.1 mm

C10-10) Courroie, chaîne ou Pignons de distribution – déposée(s)
Timing belt, chain or gears – dismounted



- Type / Type: **Silent chain**
- Pas / Pitch : **6.35 ±0.1 mm**
- Nb de dents / Nb of teeth : **60**
- Longueur / Length : **768 ±2 mm (exterieur/outside)**
- Largeur / Width : **9.50 ±0.1 mm**

327. ADMISSION / INTAKE

a) Matériau des trompettes <i>Material of trumpets</i>	Plastic				
b) Dimensions du conduit d'admission au niveau du papillon <i>Dimensions of the intake pipe at the throttle valve</i>	40.0			+0.1 / -0.2 mm	
c) Distance entre axe papillons et culasse <i>Distance between throttle valve and head</i>	39			± 2 mm	
d) Diamètre max. de tête de soupape <i>Maximum diameter of the valve head</i>	27.2		± 0.1 mm		
e) Diamètre tige de soupape <i>Diameter of valve stem</i>	4.5		+0 -0.2 mm		
g) Matière soupape <i>Valve material</i>	Ti				
i) Matière coupelle ressort <i>Spring plate material</i>	Al				
				d1) Angle de la tête de soupape <i>Angle of valve head</i>	45.0° deg ± 30 min
				f) Longueur de soupape <i>Valve length</i>	95.5 ± 1.5 mm
				h) Masse soupape mini <i>Min valve weight</i>	15 g
				j) Masse coupelle ressort min <i>Min spring plate weight</i>	3 g

C11-1) Boite à air - déposé
airbox - dismounted



C11-2) boite à air - déposé
airbox - dismounted



C11-3) Boitier papillon - déposé
Throttle unit - dismounted

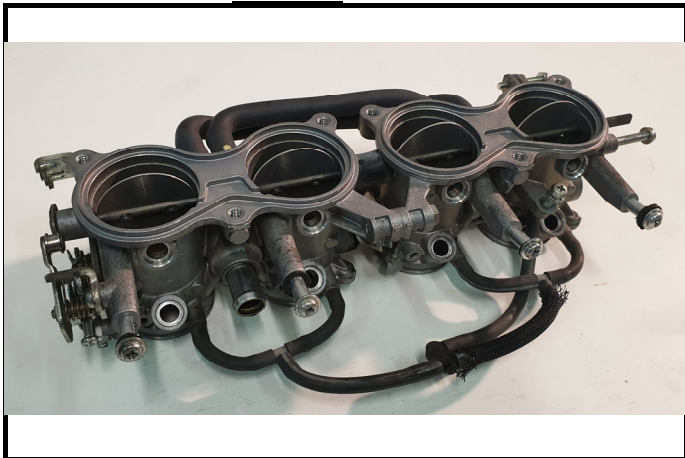

C11-4) Boitier papillon - déposé
Throttle unit - dismounted

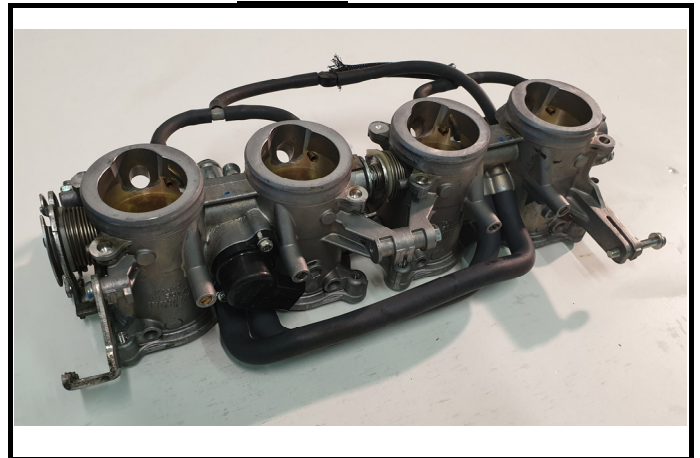

C11-5) Soupape admission - déposée
Intake valve - dismantled



C11-6) Coupelle de ressort admission - déposée
Intake spring plate - dismantled



328. ECHAPPEMENT / EXHAUST

a) Matériau de l'échappement Material of exhaust	Inox Stainless steel				
c) Epaisseur minimum des tubes Minimum thickness of tubes	0.9	mm			
d) Diamètre maximum de soupape Maximum diameter of the valve	22.1	± 0.1 mm	d1) Angle de la tête de soupape Angle of valve head	45°	deg ± 30 min
e) Diamètre tige de soupape Diameter of valve stem	4.5	+0 -0.2 mm	f) Longueur de soupape Valve length	96	± 1.5 mm
g) Matière soupape Valve material	Ti		h) Masse soupape mini Min valve weight	11	g
i) Matière coupelle ressort Spring plate material	Al		j) Masse coupelle ressort mini Min spring plate weight	3	g

C12-1) Soupape échappement - déposée
Exhaust valve - dismantled



C12-2) Coupelle de ressort échappement - déposée
Exhaust spring plate - dismantled



ECHAPPEMENT / EXHAUST

Dessin de l'échappement complet
Drawing of the complete exhaust

III-L1) Echappement / Exhaust

All dimensions in mm

All diameters are internal diameters

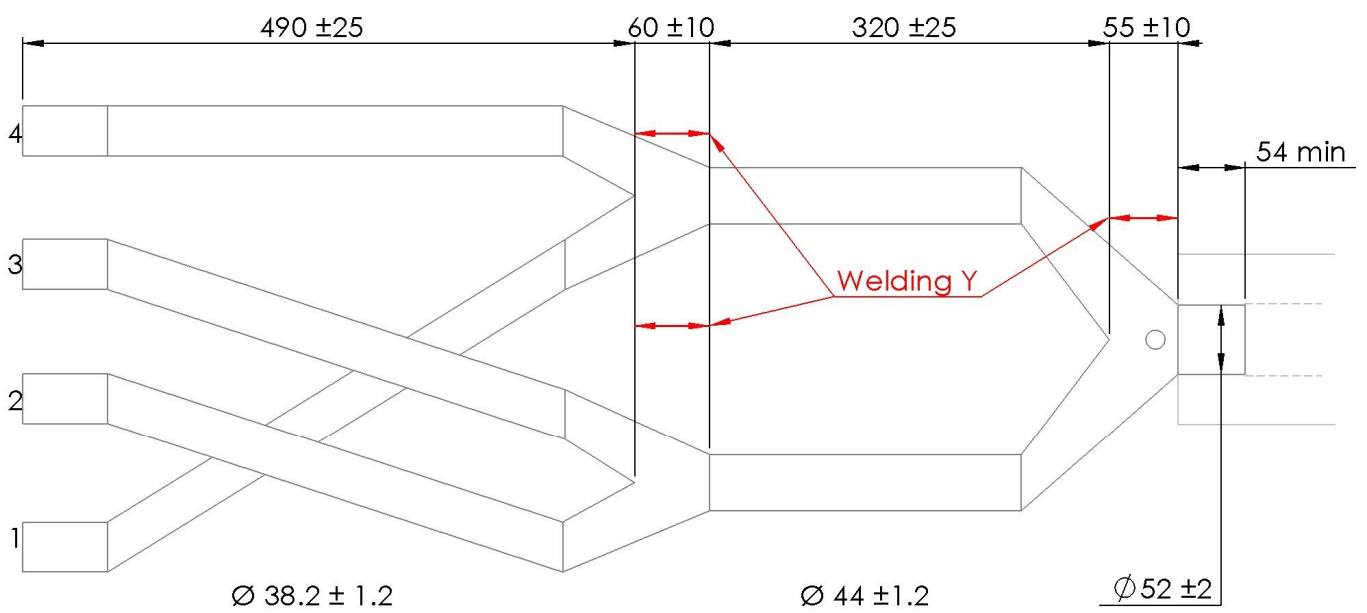

SILENCIEUX / SILENCER

Dessin du silencieux complet
Drawing of the complete silencer

III-L3) Silencieux / Silencer

All dimensions in mm

All diameters are internal diameters

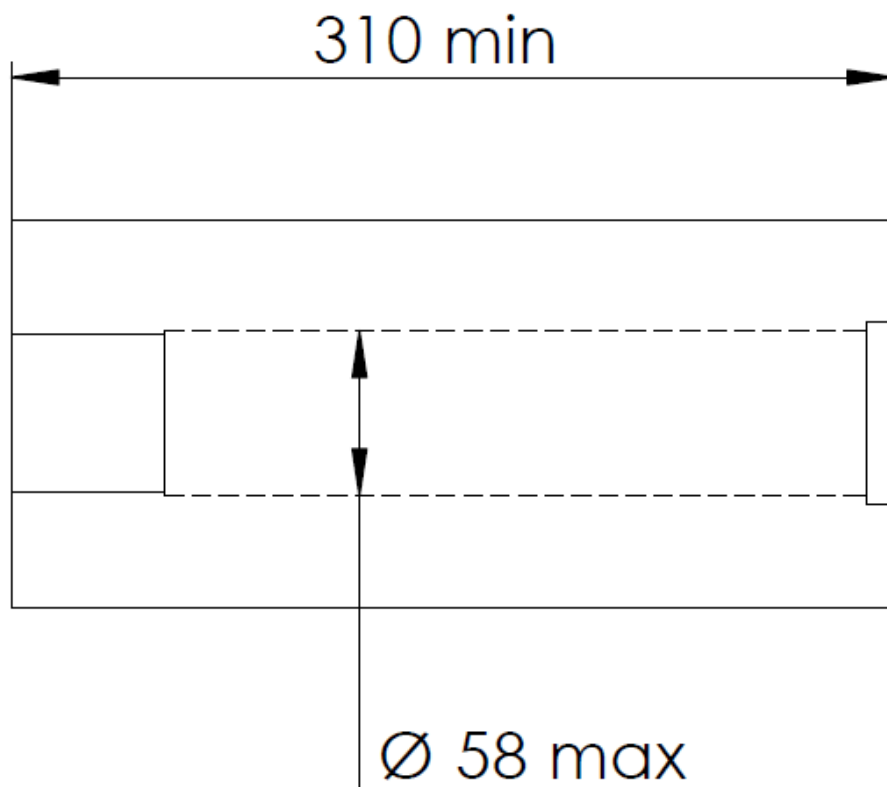

SECTION OF SILENCER

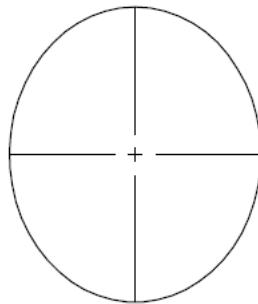

Free shape with
Min surface of 125 cm²

331. SYSTEME DE REFROIDISSEMENT / COOLING SYSTEM

c) Type de la pompe à eau
Origin of the water pump

Mechanical

C13-3) Pompe à eau - déposée
Water pump - dismantled



C13-4) Pompe à eau montée sur le moteur
Water pump mounted on engine



C13-5) Roue de turbine de pompe à eau
Turbine wheel of water pump



III-M2) Roue de turbine de pompe à eau
Turbine wheel of water pump

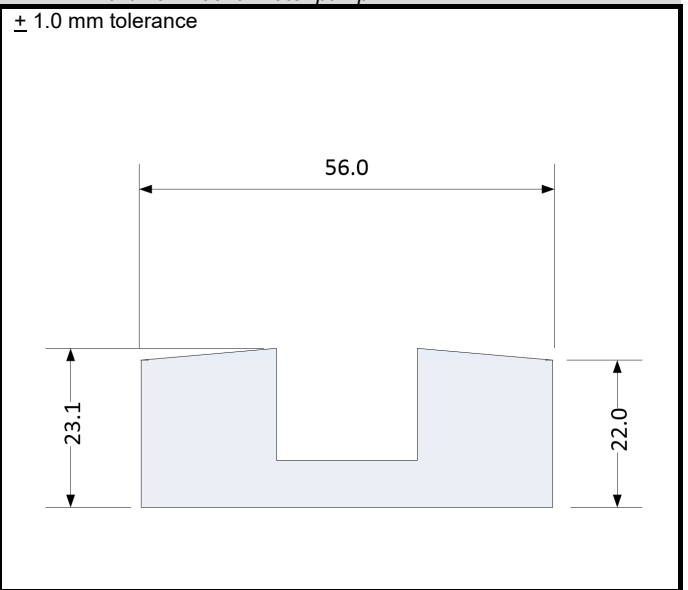

333. SYSTEME DE LUBRIFICATION / LUBRICATION SYSTEM

- a) Matériau du carter d'huile
Material of oil sump

Aluminium

C14-1) Carter d'huile - déposé
Oil sump - dismounted

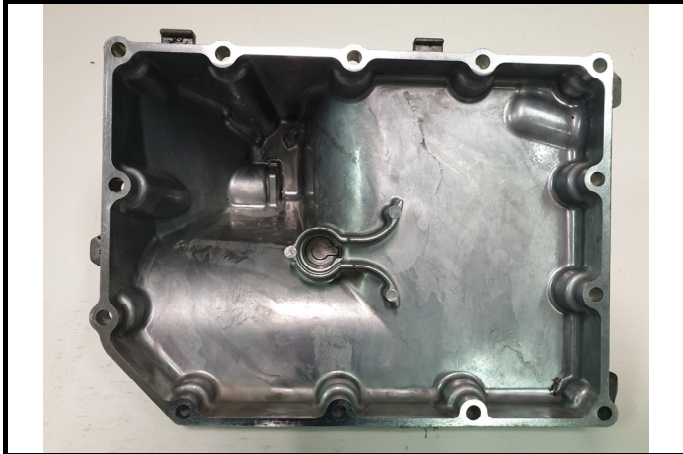

C14-2) Carter d'huile - déposé
Oil sump - dismounted



C14-3) Pompe à huile - déposée
Oil pump - dismounted

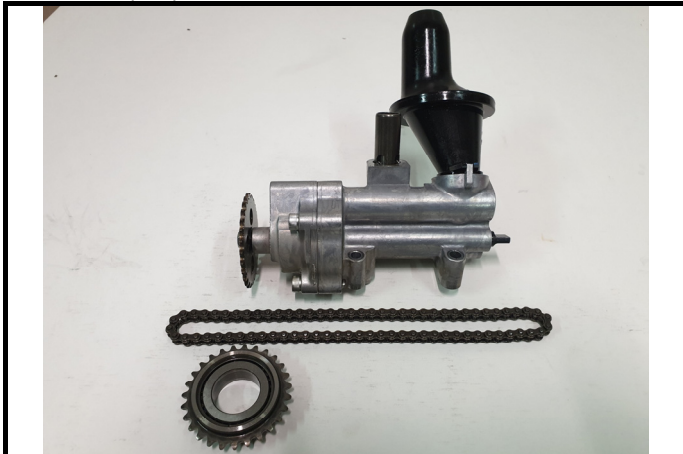

C14-3b) Pompe à huile - déposée
Oil pump - dismounted



C14-4) Pompe à huile - montée dans son emplacement
Oil pump - mounted in its location



4. ESSENCE / FUEL

402. POMPE A CARBURANT / FUEL PUMP

a) Pressure maximale Max fuel pressure	3.6	barA
---	------------	------

5. EQUIPEMENT ELECTRIQUE / ELECTRICAL EQUIPMENT

502. ALTERNATEUR / GENERATEUR / DEMARREUR / ALTERNATOR / GENERATOR / STARTER

a) Diamètre extérieur Rotor <i>Rotor External diameter</i>	118.1	+/- 0.5 mm
b) Diamètre intérieur Rotor <i>Rotor Internal diameter</i>	108.4	+/- 0.5 mm
c) Nombre de pôles du Rotor <i>Number of Rotor pôles</i>	20	
d) Largeur des pôles du Rotor <i>Width of Rotor pôles</i>	18.7	+/- 0.5 mm
e) Diamètre extérieur du Stator <i>Stator external diameter</i>	106.9	+/- 0.5 mm
f) Diamètre intérieur du Stator <i>Stator internal diameter</i>	62.8	+/- 0.5 mm

C15-1) Rotor - déposé
Rotor - dismounted



C15-2) Stator - déposé
Stator - dismounted



504. DÉMARREUR / STARTER

a) Référence démarreur: <i>Starter reference:</i>	31100-14J10-000	
a) Roue libre: Nb de dents <i>Free wheel : Teeth nb :</i>	65	
b) Largeur de la roue libre : <i>Free wheel width :</i>	6.7	+/- 0.5 mm

C16-1) Démarreur - déposé
Starter - dismounted

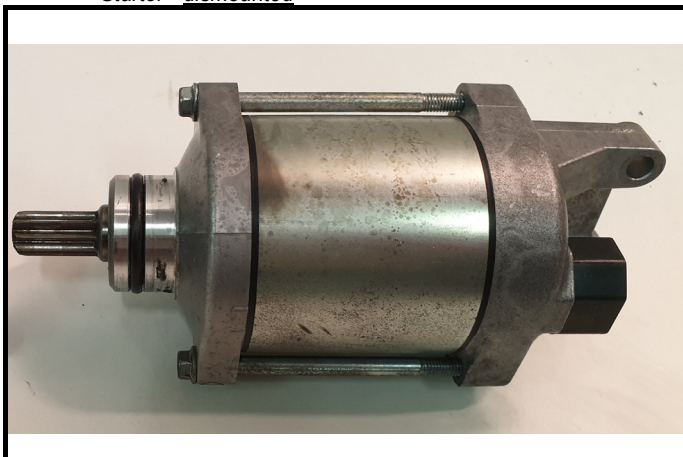

C16-2) Roue libre - déposée
Free Wheel - dismounted

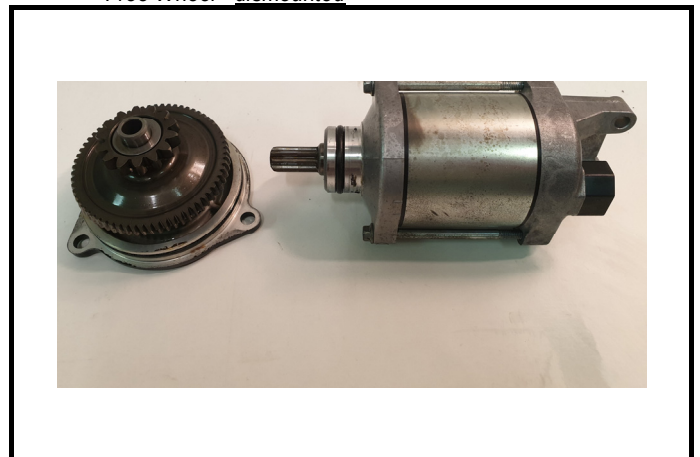

6. TRANSMISSION / POWER TRAIN

602. EMBRAYAGE / CLUTCH

a) Masse ensemble Assembly weight	4500		g		+/- 50 g
b) Disques Menants Driving disks	a1) Nombre Number	9 frités	a2) Epaisseur Thickness	2.8	+/- 0.5mm
c) Disques Menés Driven disks	b1) Nombre Number	8 lisses	b2) Epaisseur Thickness	2.0	+/- 0.5mm

C17-1) Embrayage complet - monté
Complete Clutch - mounted

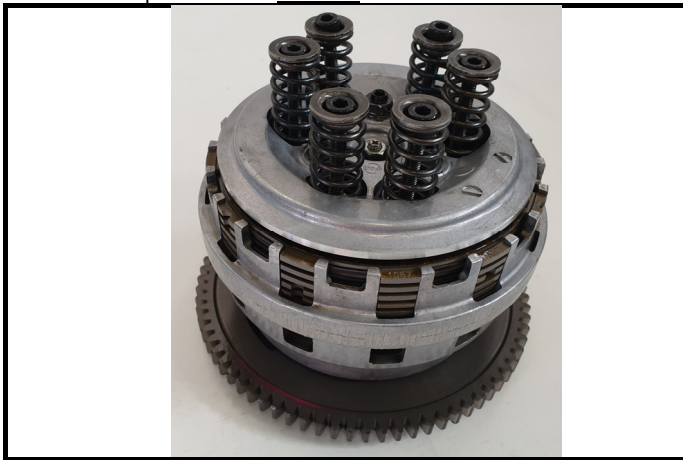

C17-2) Disque menant - déposé
Driving disk - dismounted

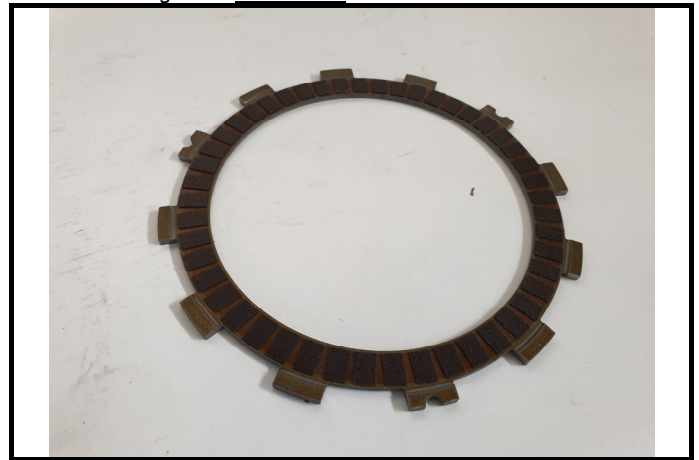

C17-3) Disque mené - déposé
Driven disk - dismounted



C17-4) Ressort
Spring



602 EMBRAYAGE / CLUTCH / ANTI DRIBLE

d) Rondelles ressorts
Spring washer

a1) Nombre
Number

2

a2) Epaisseur
Thickness

0.9

+/- 0.1mm

C17-5) Système complet
Complete system



C17-6) Came pour pilotage embrayage
Cam for clutch drive



C17-7) Came d'embrayage – vue de face
Clutch cam – face view



C17-8) Came d'embrayage - vue de dos
Clutch cam – rear view



603. BOITE DE VITESSES / GEARBOX

a) Emplacement:
Location: **Carter moteur**
Engine block

b) Rapp. Primaire sur Vilebrequin:
Primary ratio on crankshaft **39**

c) Rapp. Primaire sur Embrayage:
Primary ratio on clutch **77**

	d) Primaire: Layshaft:	e) Secondaire: Pinionshaft:	f) Materiau: Material:	g) Epaisseurs (mm): Thicknesses (mm): + 0.5mm	h) Masse (g): Weight (g): + 15 g
No. 1	16	43	Acier / Acier Steel / Steel	19 - 15 / 12 - 9.5	753 / 320
No. 2	19	40	Acier / Acier Steel / Steel	12 - 10.5 / 13.25 - 11.5	98 / 317
No. 3	21	37	Acier / Acier Steel / Steel	12 - 10.5 / 14.55 - 13	411 / 327
No. 4	23	35	Acier / Acier Steel / Steel	12 - 10.5 / 12 - 10.5	411 / 270
No. 5	23	31	Acier / Acier Steel / Steel	14.90 - 13 / 14.40 - 12	197 / 488
No. 6	26	32	Acier / Acier Steel / Steel	13.90 - 12 / 13.40 - 7.40	217 / 436

F12-1) Gear Crankshaft

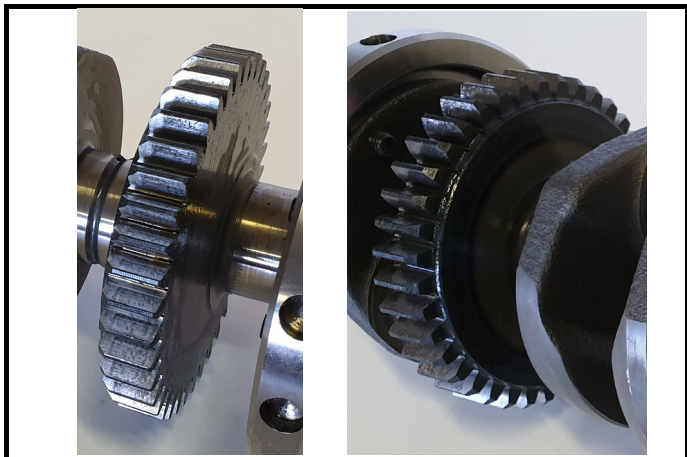

F12-2) Gear Clutch

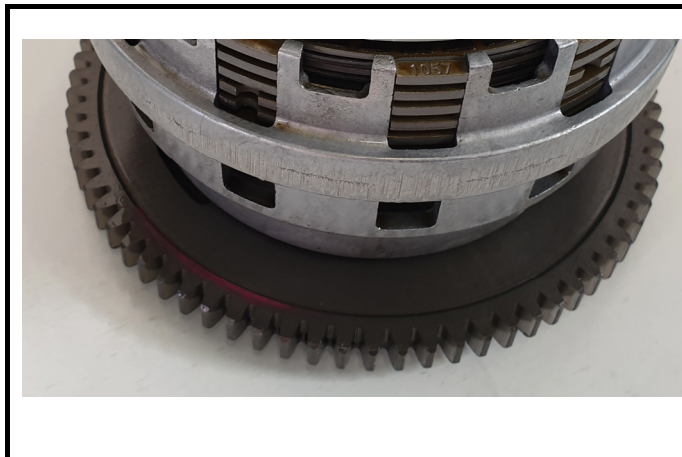

F12-3) Gear No. 1 front view



F12-4) Gear No. 1 rear view



F12-5) Gear No. 2 front view



F12-6) Gear No. 2 rear view

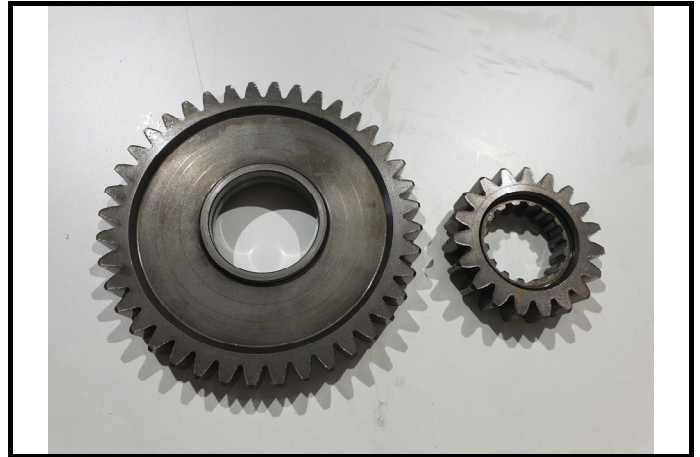

F12-7) Gear No. 3 front view



F12-8) Gear No. 3 rear view



F12-9) Gear No. 4 front view



F12-10) Gear No. 4 rear view



F12-11) Gear No. 5 front view



F12-12) Gear No. 5 rear view



F12-13) Gear No. 6 front view



F12-14) Gear No. 6 rear view



604. ASSEMBLAGE ARBRE PRIMAIRE / LAYSHAFT ASSEMBLY

a) Référence du Roulement Reference of bearing	09262-25150-000	
b) Masse du Roulement Weight of bearing	229	± 10 g
c) Largeur / Diamètres intérieurs et extérieurs du Roulement Width / External and internal diameters of bearing	17 / 25 – 62	±0.1 mm
d) Masse de l'Arbre primaire Weight of layshaft	0.752	± 10 g
e) Matériau de l'Arbre primaire Material of layshaft	Acier / Steel	

F7-1) Roulement
Bearing

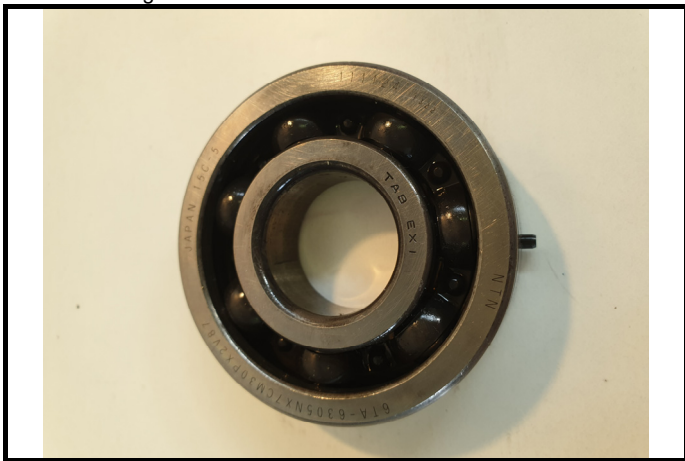

F7-2) Arbre primaire
Layshaft



605. ASSEMBLAGE ARBRE SECONDAIRE / PINIONSHAFT / MAINSHAFT ASSEMBLY

a) Matériau de l'Arbre secondaire <i>Material of pinionshaft/mainshaft</i>	Acier / Steel	
b) Masse de l'Arbre secondaire <i>Weight of pinionshaft/mainshaft</i>	0.578	± 10 g
c) Référence du Roulement gauche <i>Reference of left mainshaft bearing</i>	09262-28045-000	
d) Largeur / Diamètres intérieurs et extérieurs du Roulement gauche <i>Width / External and internal diameters of mainshaft bearing</i>	18 - 28 - 68	± 0.1 mm
e) Masse du Roulement gauche <i>Weight of left mainshaft bearing</i>	286	± 10 g
f) Référence du Roulement droit <i>Reference of right mainshaft bearing</i>	09263-20069-000	
g) Largeur / Diamètres intérieurs et extérieurs du Roulement droite <i>Width / External and internal diameters of right mainshaft bearing</i>	17.5 - 34 - 20	± 0.1 mm
h) Masse du Roulement droit (avec support et clips) <i>Weight of right mainshaft bearing (With support and clips)</i>	209	± 10 g
i) Largeur / Diamètres intérieurs et extérieurs du Roulement à aiguilles des rapports <i>Width / External and internal diameters of ratio needle bearings</i>	13.5 - 34 - 20	± 0.1 mm
j) Masse du Roulement à aiguilles des rapports <i>Weight of ratio needle bearings</i>	53	± 5 g
k) Référence du Roulement Aiguille <i>Material of the hub</i>	09263-20087-000	
l) Nombre de crabot sur chaque pignon <i>Number of dog on each gear</i>	1 : 3 / 2 : 3 / 3 : 5 / 4 : 5 / 5 : 6 / 6 : 6	
m) Matériau des anneaux de crabotage <i>Material of clutch rings</i>	Acier intégré aux pignons Steel integrated in gears	
n) Masse des anneaux de crabotage <i>Weight of clutch rings</i>	Intégré aux pignons Integrated to gears	

F8-1) Arbre secondaire
Pinionshaft / Mainshaft



F8-2) Roulement gauche de l'arbre secondaire
Left mainshaft bearing



F8-3) Roulement droit de l'arbre secondaire
Right mainshaft bearing



F8-4) Roulement à aiguilles des rapports
Ratio needle bearings



F8-5) Moyeu
Hub

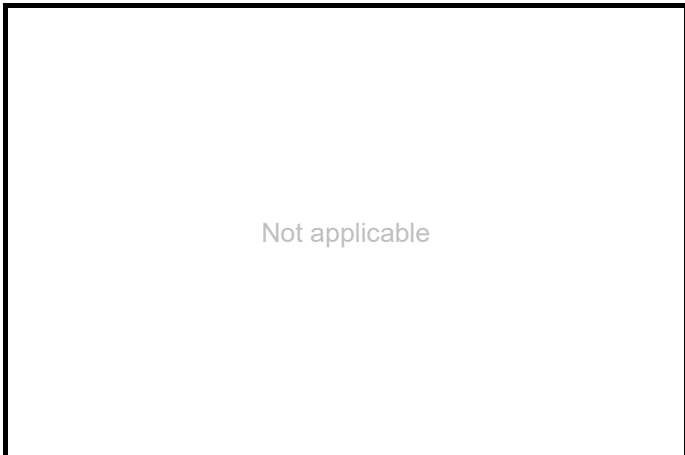

606. MECANISME DE SELECTION DES RAPPORTS / GEAR SELECTION MECHANISM

a) Matériau des fourchettes incluant l'axe Material of selector forks incl. axle	Acier Steel				
b) Masse fourchette n°1 Weight of forks n°1	70	± 5 g	b) Masse fourchette n°2 Weight of forks n°2	96	± 5 g
d) Masse axe de fourchettes Weight of shaft gear shift fork	70	± 5 g	e) Diamètre axe de fourchettes Forks axle diameter	13.95	± 0.1 mm
f) Epaisseur des doigts de fourchettes Forks finger thickness	4.85	± 0.1 mm	g) Diam. pions de guidage de fourchettes Forks locating pin diameter	5.85	± 0.1 mm
h) Matériau de l'assemblage du barillet Material of selector barrel assembly	Acier Steel		i) Masse de l'assemblage du barillet Weight of selector barrel assembly	615	± 5 g

F9-1) Fourchette n°1 et axe :
Selector forks n°1 and axle:



F9-2) Fourchette n°3
Selector forks n°3



F9-4) Assemblage du barillet
Selector barrel assembly



F9-5) Assemblage du barillet
Selector barrel assembly



ERRATUM

- Date 01/12/2020 - Page 14 : picture of the ECU removed - Done by Vincent Pereme
- Date 08/03/2022 - Page 8 : minimum height of cylinderhead modified from 103.9mm to 113.9mm - Done by Vincent Pereme
- Date 08/03/2022 - Page 19 : picture C11-1 and C11-2 of the Airbox modified - Done by Vincent Pereme
- Date 08/03/2022 - Page 21 : tolerance of the Y measurement on all homologated XC engines from ± 5 mm to ± 10 mm - Done by Vincent Pereme
- Date 08/03/2022 - Page 25 : max fuel pressure permitted increased from 3.5 bar to 3.6 bar - Done by Vincent Pereme



FEDERATION INTERNATIONALE DE L'AUTOMOBILE

XC Engine SUZUKI GSXR 2011 - 2017

Homologation N°

2020-01-XCAR-GSXR

Extension N°

ER 01/01

FICHE D'EXTENSION D'HOMOLOGATION HOMOLOGATION EXTENSION FORM

Homologation valable à partir du
Homologation valid as from

01/12/2023

ER Erratum / Erratum

TOUTES LES CARACTERISTIQUES FIGURANT DANS CETTE FICHE ANNULENT ET REMPLACENT CELLES FIGURANT DANS LA FICHE DE BASE ET LES EXTENSIONS PRECEDENTES

ALL SPECIFICATIONS FEATURING ON THIS FORM CANCEL AND REPLACE THOSE FEATURING ON BASIC HOMOLOGATION FORM AND THE PREVIOUS EXTENSIONS

328. ECHAPPEMENT / EXHAUST

ECHAPPEMENT / EXHAUST

Dessin de l'échappement complet
Drawing of the complete exhaust

III-L1) Echappement / Exhaust

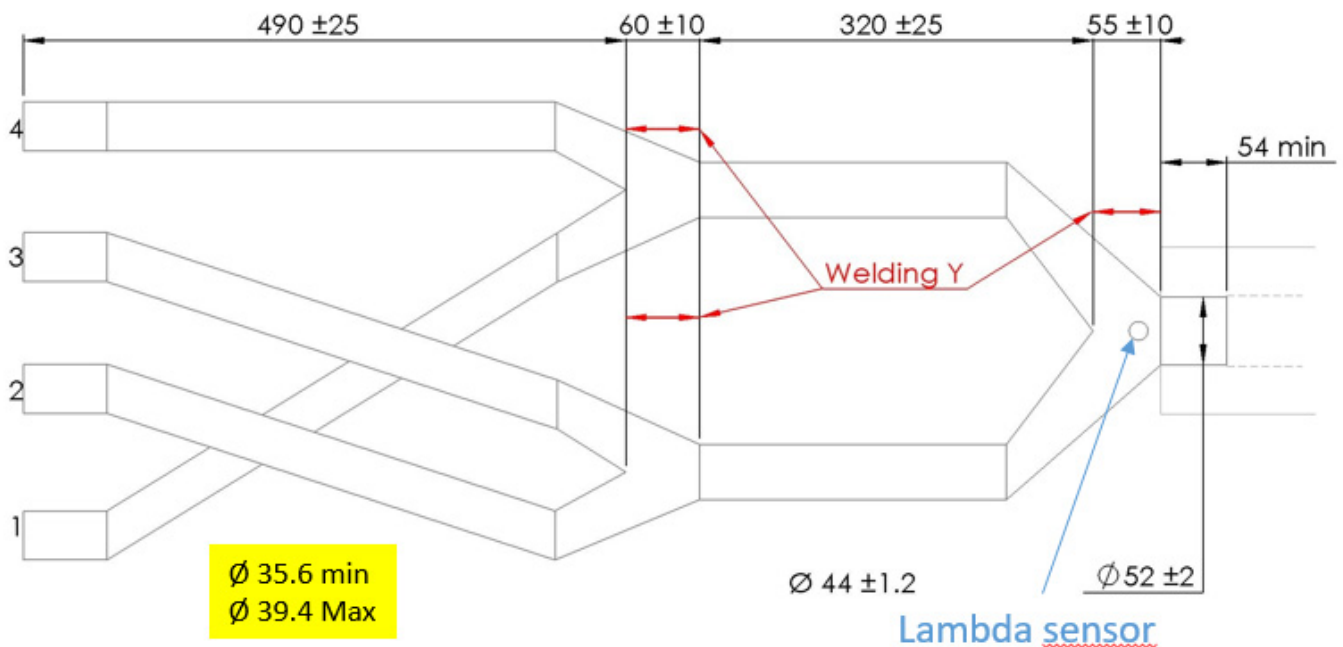

All dimensions in mm

All diameters are internal diameters